

BNC-Stecker / BNC-Plug
Artikel Nr. / Part-no.: 7721

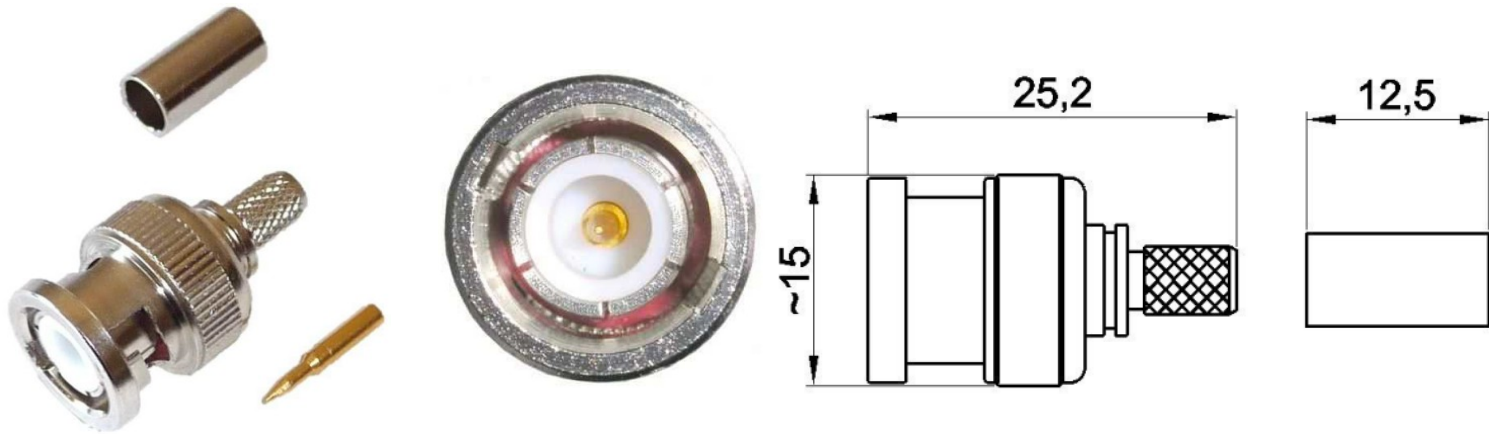

Norm: 169-8

Kabeltypen / Cable Types: Aircell 5 / H2005 / LMR 200

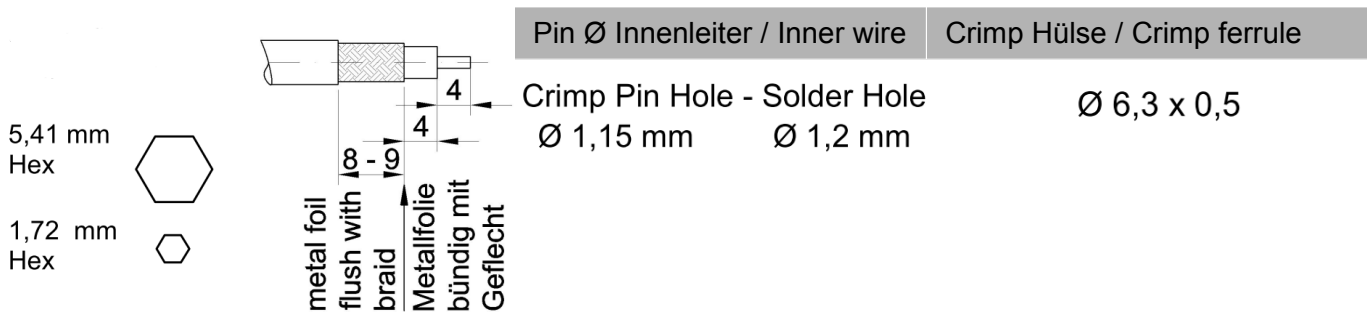

Mechanische Eigenschaften / Mechanical specifications:

Isolierhülse / Isolator	PTFE
Material Dichtung Steckergesicht / gasket in mating face	Silikon / Silicone
Oberfläche / Surface	Vernickelt / nickel plated
Metallteile außer Pin / Metal parts excl. pin	CuZn39Pb3
Pin (diamagnetisch) / Pin (diamagnetic)	vergoldet / gold plated
Temperaturbereich / Operating temperature	-45°C / +155°C
Gewicht / Weight	8g
RoHs conform / RoHs compliant	Ja / Yes
Schutzklasse / Protection class	IP 40

Elektrische Eigenschaften / Electrical specifications:

Betriebsspannung / Working voltage	≤ 500 V RMS
Impedanz / Impedance	50 Ω
Isolationswiderstand / Isulation resistance	≥ 5 GΩ
Frequenz bis zu / Frequency up to	4 GHz
Durchgangswiderstand innen / Inner contact resistance	≤ 1,5 mΩ
Durchgangswiderstand außen / Outer contact resistance	≤ 1,0 mΩ